

Supplied By:

**TRENCHDRAIN
SUPPLY**

877-903-7246

www.trenchdrainsupply.com

Grate Artistry

22nd Edition Tree Grate Collection

Architecturally Designed • Eco-Friendly Materials • Sturdy 2-Piece Construction

NEENAH



FOUNDRY

"Word on the Street is Neenah"



Architects and Landscape Designers have found that Neenah Foundry's cast iron tree grates and fabricated steel tree guards continue to be the strongest, most cost-effective solution for protecting and complementing trees in urban environments.

With quality tree grate castings produced entirely in the USA, you can specify Neenah Foundry with confidence, and choose from the largest selection of tree grates in the industry.

2-Piece Tree Grates

Neenah is well known in the industry as a manufacturer of two-piece tree grates. We recommend using two-piece (180 degree section) tree grates for the best stability and longevity.

Catalog Contents

Adirondack Collection	Pg 4
Avenue Collection	Pg 5
Metropolitan Collection	Pg 6
Parkway Collection	Pg 8
Boulevard Collection	Pg 10
Capitol Collection	Pg 11
Majestic Collection	Pg 12
Retrofit Collection	Pg 13
Distinctive Collection	Pg 14
Greenwich Collection	Pg 15
Extended Collection	Pg 16
Custom Castings	Pg 17
Tree Guards	Pg 18
Planting & Lighting	Pg 19
Installation	Pg 20
Trench Systems	Pg 21
Reference Guides	Pg 22

Specifications

- 1. General:** Tree grates and frames shall be of cast iron as manufactured by Neenah Foundry Company.
- 2. Material:** Gray Iron castings shall conform to A.S.T.M. A-48, Class 35 or better.
- 3. Finish:** All castings shall be manufactured true to pattern; component parts shall fit together in a satisfactory manner. They shall be of uniform quality; free from blowholes, porosity, hard spots, shrinkage distortion or other defects. They shall be well cleaned by blasting.
- 4. Paint:** Tree grates and frames shall be furnished without paint or primer as the standard. See page 19 for details on available paint finishes.
- 5. Submittals:** Manufacturer's shop drawings shall be submitted to the architect/engineer for approval prior to manufacture. The architect/engineer shall retain the right to reject castings not conforming to this specification and/or approved submittal drawings.

Note: Architect/Engineer must specify tree grate number and frame if required. Paint requirements and security bolting requirements must also be specified. When selecting the tree grate and planning its location, the safety of cyclists, pedestrians and persons with disabilities must be considered. Contact your local Neenah Foundry representative or our Inside Sales Service staff for complete details and submittal drawings of our entire tree grate line.

Why Cast Iron?

Unlike steel, cast iron is inherently resistant to continued corrosion. When left unpainted, cast iron tree grates and frames will remain unchanged for decades. Cast iron tree grates from Neenah Foundry are strong and will stand up to urban abuse. (Note: not recommended for vehicular traffic.) Cast iron tree grates are heavy enough to deter unauthorized removal without the need for lock down devices.

Los Angeles Approved Grates

Neenah Foundry has the largest variety of proof load tested and approved tree grates for the city of Los Angeles. (Requires a 188 lbs/sf proof load on a 10 x 10 x 1 contact area with a max .5" deflection. The test is then continued without measuring further deflection to a 450 lbs/sf load.)

LA approved grates are noted in green.



In support of the Green Initiative, Neenah Foundry is pleased to report that our products contain a minimum of 85% recycled content in the form of a minimum of 35% consumer-generated scrap metal and minimum of 50% industrial-generated scrap metal.

Adirondack Collection

The ADIRONDACK collection is reminiscent of older traditional tree grate offerings and may be an excellent choice for a historical site. Contact us to help you with sizes or shapes – our Neenah sales staff is interested in your ideas.

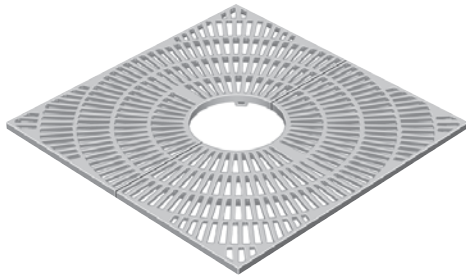

R-8742 • 48" x 48"

18" diameter expandable tree opening. 285 pounds per set. Available with light openings.

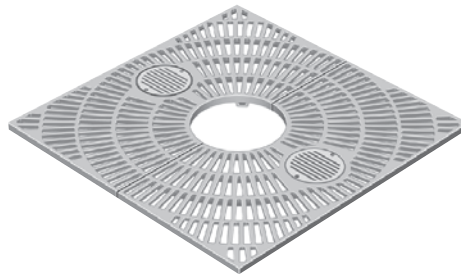

R-8742-A1 • 60" x 60"

18" diameter expandable tree opening. Bolted light opening grates (10.375") for use with sub-grade lighting. 396 pounds per set. (Available without light openings, order as **R-8742-A**. 418 pounds per set.)

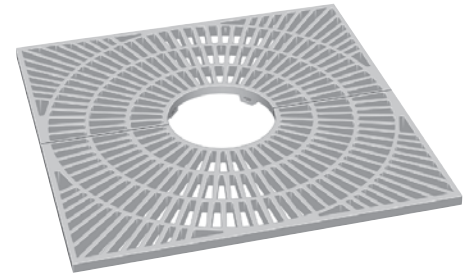

R-8746-A • 60" x 60"

18" diameter expandable tree opening. 414 pounds per set.

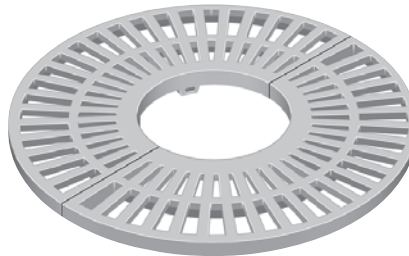

R-8827 • 31.75" Round

12" diameter tree opening. 110 pounds per set.

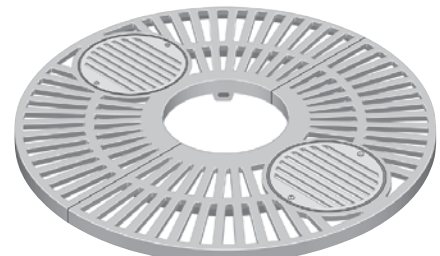

R-8827-A1 • 39.75" Round

12" diameter tree opening. Bolted light opening grates (10.375") for use with sub-grade lighting. 170 pounds per set. Available with 14" tree opening.

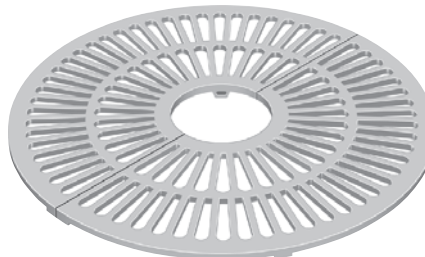

R-8833 • 50" Round

12" diameter tree opening. 266 pounds per set. Available with light opening. (Also available as 42" diameter 2-piece grate with 10" diameter expandable tree opening, order as **R-8829**. 170 pounds per set.)

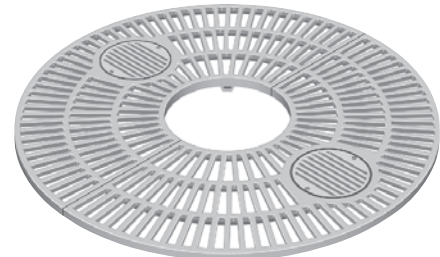

R-8837-1 • 60" Round

18" diameter tree opening. Bolted light opening grates (10.375") for use with sub-grade lighting. 320 pounds per set. (Available without light openings, order as **R-8837-A**. 308 pounds per set.)

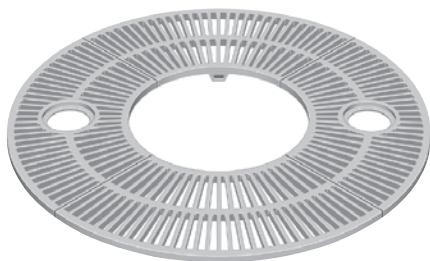

R-8860 • 93" Round

Four-piece, with 40" diameter opening. For use with sub-grade lighting. 9.5" openings. Support at section joint is required — furnished by installer. 640 pounds per set. Also available without light openings.

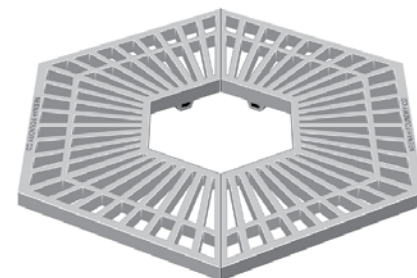

R-8950 • 44.5" Hex

16.5" hexagon tree opening. 345 pounds per set.

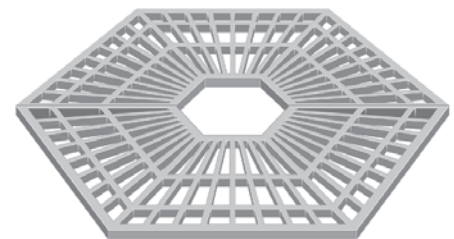

R-8955 • 60" Hex

15.75" hexagon tree opening. 540 pounds per set.

Looking for a clean, simplified radial pattern for your public areas? The AVENUE collection has the sizes you need and the narrow slot openings your plans may require. Need a different size? Contact Neenah to discuss additional options.

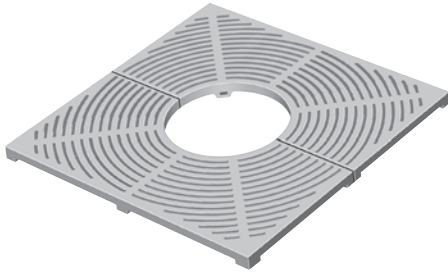

R-8704 • 30" x 30"
12" diameter expandable tree opening. .25" slot openings.
100 pounds per set.
R-8704 is also a Los Angeles approved grate.

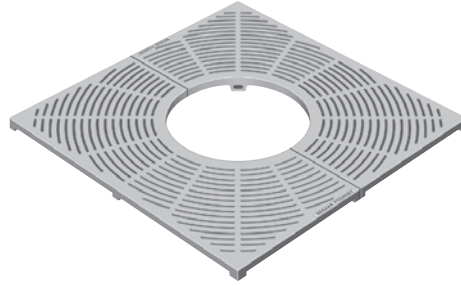

R-8704-A • 36" x 36"
16" diameter expandable tree opening. .25" slot openings.
115 pounds per set. Available with corner light openings.
9.5" x 1" grate or 7.875" x .75" lid.
R-8704-A LA
Order as **R-8704-A LA** for Los Angeles approved grate.

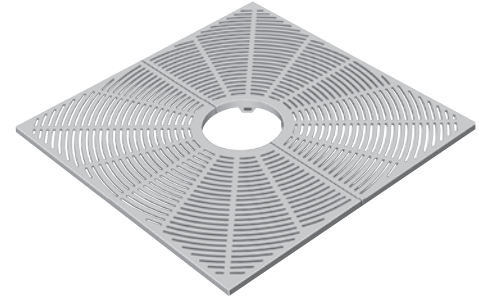

R-8710 • 48" x 48"
12" diameter expandable tree opening. .375" slot openings.
Available with cast 16" or 24" diameter tree opening and
with light openings. 260 pounds per set. (Also available as 48"
round 2-piece grate with 16" diameter expandable tree opening,
order as **R-8882**. 298 pounds per set.)
R-8710 is also a Los Angeles approved grate.

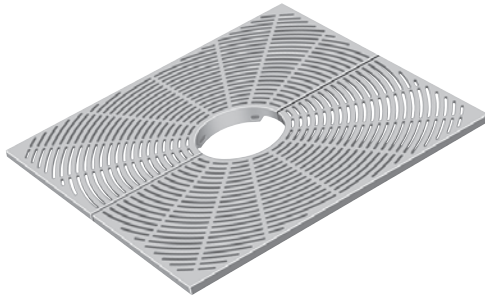

R-8712 • 60" x 60"
16" diameter expandable tree opening. .375" slot openings.
580 pounds per set. Available with light openings.

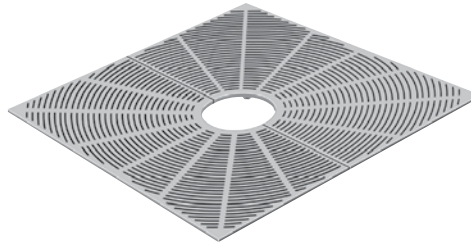

R-8715 • 72" x 72"
16" diameter expandable tree opening. .25" slot openings.
700 pounds per set. Available with light openings.

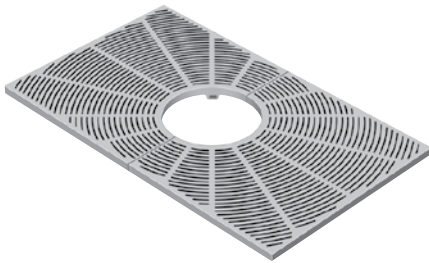

R-8810 • 36" x 60"
16" diameter expandable tree opening.
.25" slot openings. 232 pounds per set.
R-8810 is also a Los Angeles approved grate.

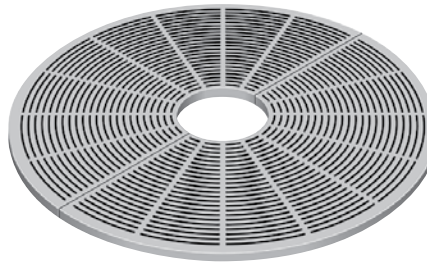

R-8872 • 55.25" Round
12" diameter expandable tree opening.
.25" slot openings. 270 pounds per set.

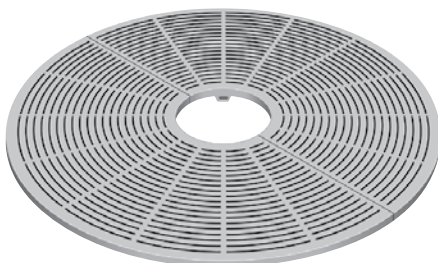

R-8876 • 72" Round
16" diameter expandable tree opening. Available with cast 18" diameter
tree opening .25" slot openings. 622 pounds per set. (Available with
light openings, order as **R-8876-1**. 606 pounds per set.)

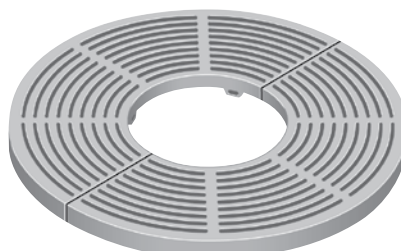

R-8881 • 30" Round
12" diameter expandable tree opening. .25" slot openings.
84 pounds per set.

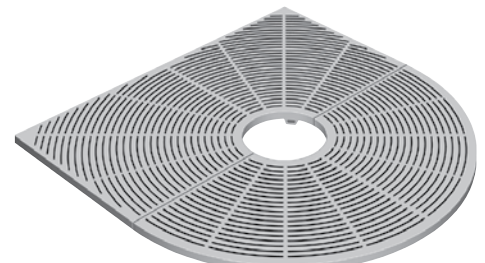

R-8939 • 72" Combo
16" diameter expandable tree opening. .25" slot openings.
661 pounds per set. Available with light openings.

Metropolitan Collection

Our most popular concept, the METROPOLITAN collection provides narrow slot openings, an eye-appealing pattern and is available in a wide variety of sizes and shapes. Don't see exactly what you want? Give us a call!

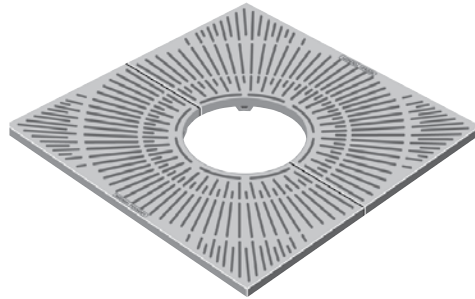

R-8706-1A • 48" x 48"
18" diameter expandable tree opening. .25" slot openings (Available with light openings, order as **R-8706-A**). 330 pounds per set.
R-8706-1A is also a Los Angeles approved grate. Available with light openings.

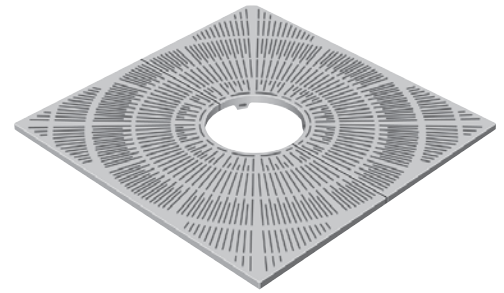

R-8707 • 60" x 60"
18" diameter expandable tree opening. Available with cast 24" tree opening. .25" slot openings. 525 pounds per set. Available with light openings.
R-8707-LA
Order as **R-8707-LA** for Los Angeles approved grate. Only available with 18" diameter tree opening.

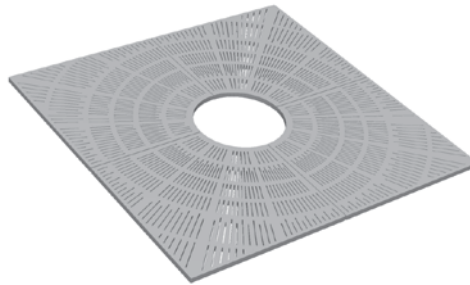

R-8784 • 95.125" x 95.125"
26" tree opening. .25" slot openings. 4-piece grate. 1588 pounds per set. Support at section joint is required — furnished by installer.

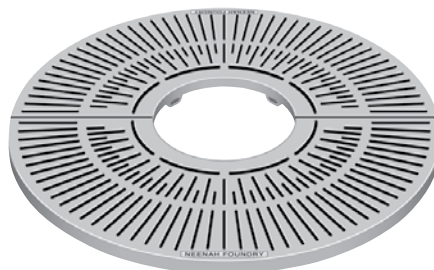

R-8834 • 36" Round
12" diameter expandable tree opening. .25" slot openings. 126 pounds per set.

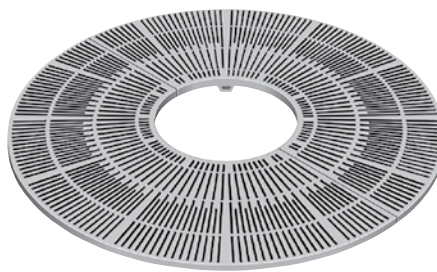

R-8880-A • 72" Round
24" diameter expandable tree opening. .25" slot openings. 600 pounds per set. Available with light openings. 36" tree opening available with no light opening.

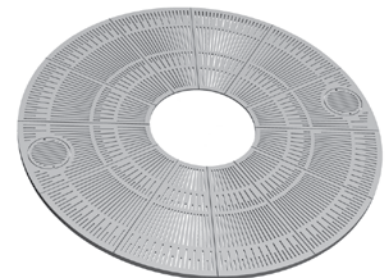

R-8883 • 96" Round
28" diameter tree opening. .25" slot openings. 960 pounds per set. Supplied in 12 sections. Support at section joint is required — furnished by installer. Available with light openings.

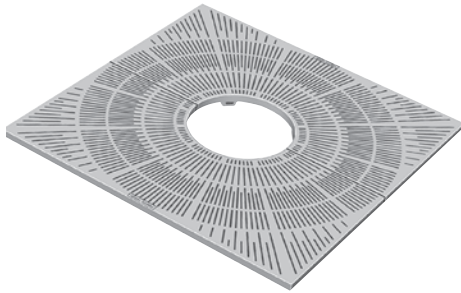

R-8709-A • 72" x 72"
24" diameter expandable tree opening. .25" slot openings.
750 pounds per set. Available with light openings.

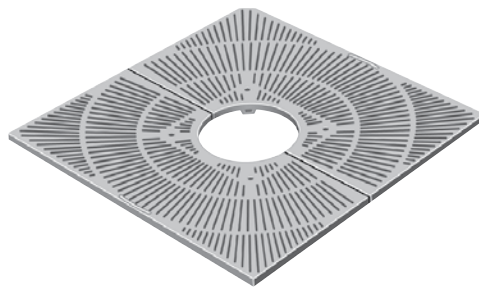

R-8714-A • 60" x 60"
18" diameter tree opening. .375" slot openings. Four 1"
diameter holes for staking tree. 520 pounds per set.
Available with light openings.
R-8714-ALA
Order as **R-8714-ALA** for Los Angeles approved grate.

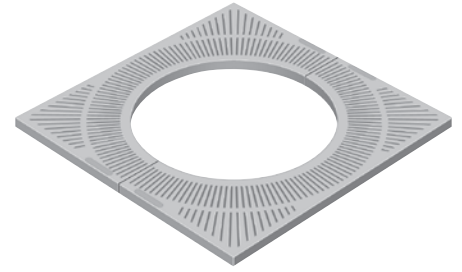

R-8719 • 48" x 48"
32" diameter expandable tree opening. 302 pounds per set.

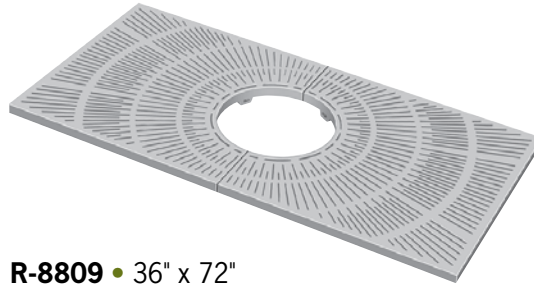

R-8809 • 36" x 72"
18" diameter expandable tree opening. .375" slot openings. 334 pounds per
set. (Available as 48" x 72", order as **R-8815-1**. 480 pounds per set.)
R-8809 is also a Los Angeles approved grate.

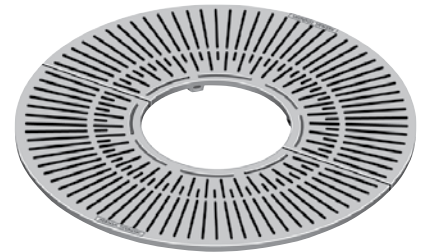

R-8830-A1 • 48" Round
18" diameter expandable tree opening. .25" slot openings.
252 pounds per set. (Available with light openings, order as
R-8830-1. 268 pounds per set.)
R-8830-A1 or **R-8830-1** are also Los Angeles approved grates.

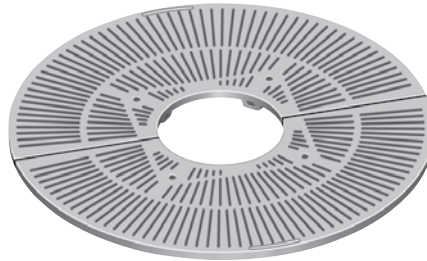

R-8869-A • 60" Round
18" diameter tree opening. .375" slot openings.
Four 1" diameter holes for staking tree. 356 pounds per set.
R-8869-ALA
Order as **R-8869-ALA** for Los Angeles approved grate.

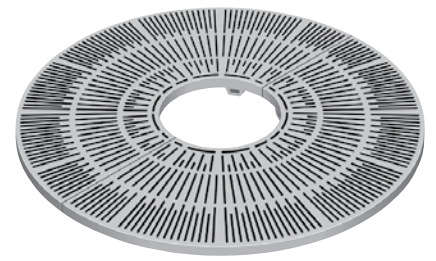

R-8870 • 60" Round
18" diameter expandable tree opening. .25" slot openings.
375 pounds per set. Available with light openings.
R-8870 is also a Los Angeles approved grate.

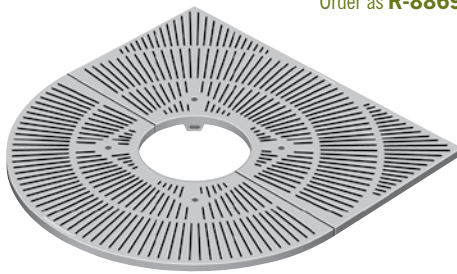

R-8933-A • 60" Combo
18" diameter tree opening. .375" slot openings. Four 1" diameter
holes for staking tree. 438 pounds per set. Available with light
openings on the square side.

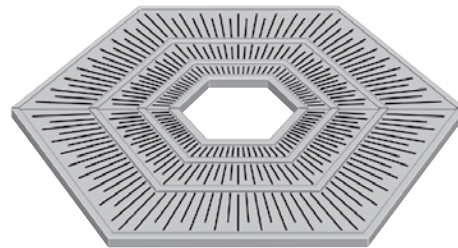

R-8965 • 60" Hex
16" hexagon tree opening.
.25" slot openings. 360 pounds per set.

Parkway Collection

Our PARKWAY collection of grates is our largest and most varied. The wide range of sizes and shapes allows for a great deal of options to incorporate into your design.

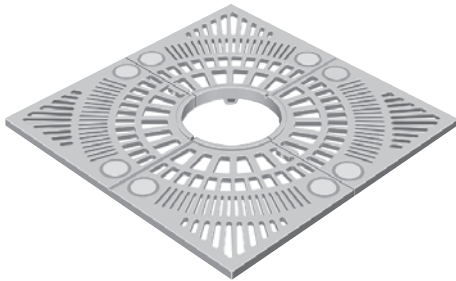

R-8721-A • 48" x 48"
15" diameter expandable tree opening. 340 pounds per set.

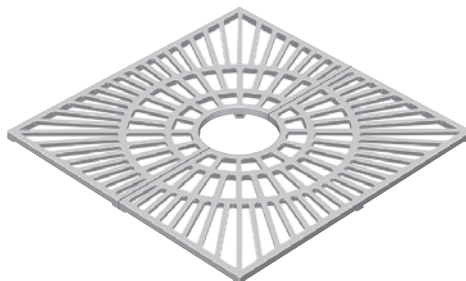

R-8726 • 48" x 48"
12" diameter expandable tree opening. 265 pounds per set. Available with light openings.

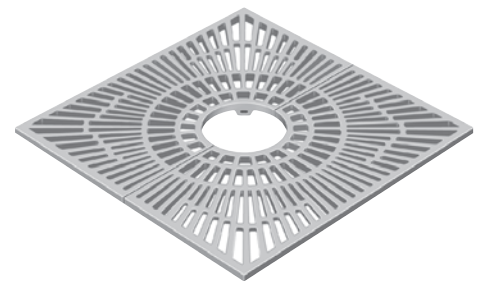

R-8728-A • 60" x 60"
15.75" diameter expandable tree opening. 635 pounds per set. Available with cast 32" tree opening.

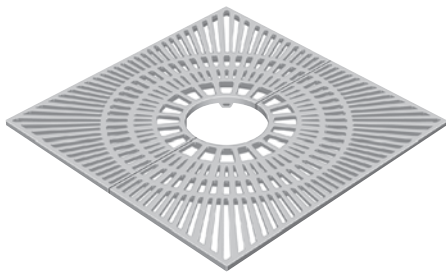

R-8738-A1 • 60" x 60"
16" diameter expandable tree opening. Bolted light opening grates (8.25" x 17.125" x 5.375") for use with sub-grade lighting. 455 pounds per set. (Available without light openings, order as **R-8738-A2**. 470 pounds per set.)

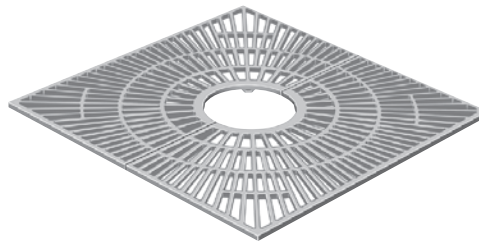

R-8740-1 • 72" x 72"
20" diameter expandable tree opening. 520 pounds per set.

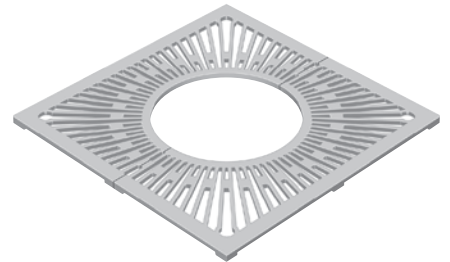

R-8750 • 48" x 48"
24" diameter tree opening. 236 pounds per set.

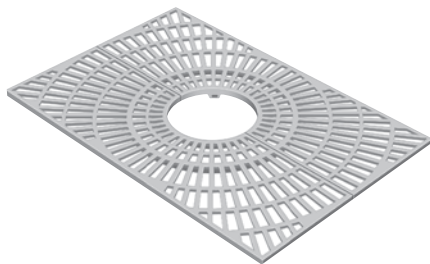

R-8802-A • 48" x 72"
18" diameter expandable tree opening. 306 pounds per set. Available with light openings.

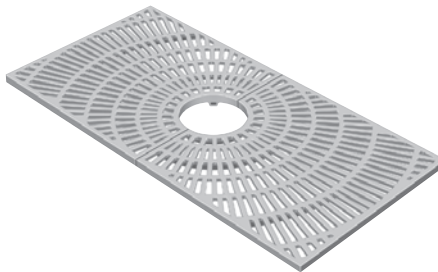

R-8808 • 36" x 72"
12" diameter expandable tree opening. Available with cast 18" and 24" tree opening. 300 pounds per set. Available with light openings.

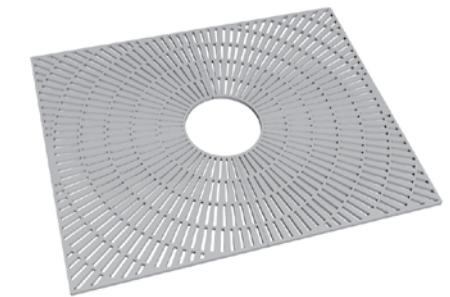

R-8821 • 95.125" x 119.125"
26" diameter tree opening. 1,536 pounds per set.

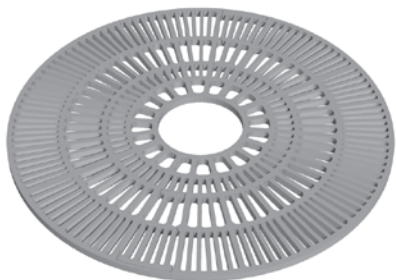

R-8855-1 • 72" Round
16" diameter expandable tree opening. Bolted light opening grates (9" x 17.143" x 4.5") for use with sub-grade lighting. 495 pounds per set. Supplied with light grates, none shown.

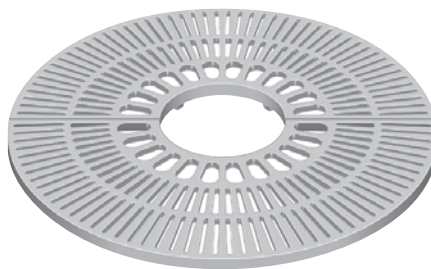

R-8855-2 • 54" Round
16" diameter expandable tree opening. 310 pounds per set.

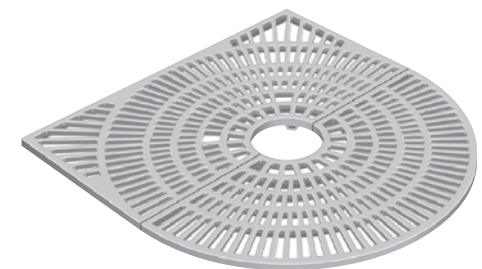

R-8929 • 62" Combo
12" diameter expandable tree opening. 501 pounds per set.

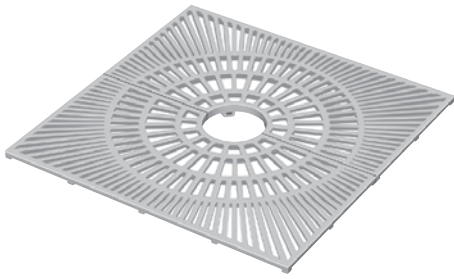

R-8734 • 60" x 60"

12" diameter expandable tree opening. 370 pounds per set.

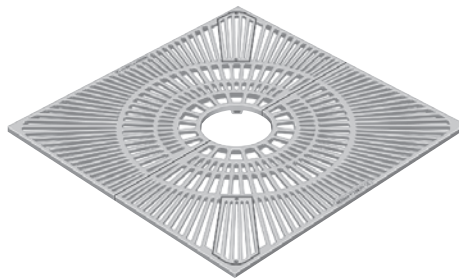

R-8738-1 • 72" x 72"

16" diameter expandable tree opening. Bolted light opening grates (10.125" x 21.75" x 5.875") for use with sub-grade lighting. 595 pounds per set. (Available without light openings, order as **R-8738-2**. 568 pounds per set.)

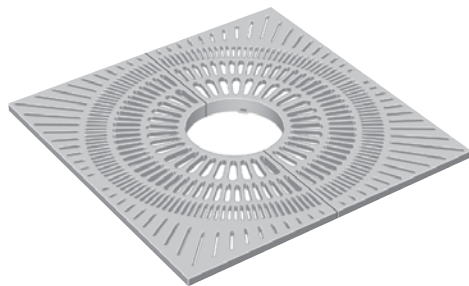

R-8752-A • 60" x 60"

18" diameter expandable tree opening. 605 pounds per set. (Available as 48" square with 12" tree opening, order as **R-8752-2**. 335 pounds per set.)

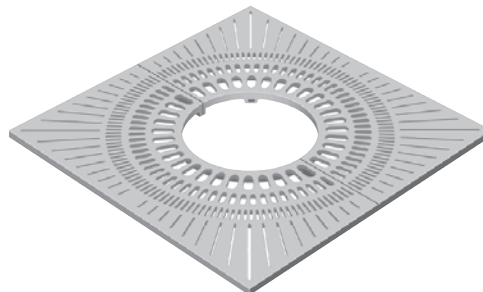

R-8752-B • 60" x 60"

24" diameter expandable tree opening. 470 pounds per set.

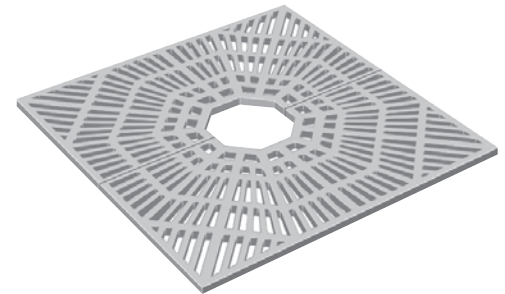

R-8766 • 64" x 64"

16" octagonal tree opening. 780 pounds per set. No tree guards available for octagonal openings. Available with light openings.

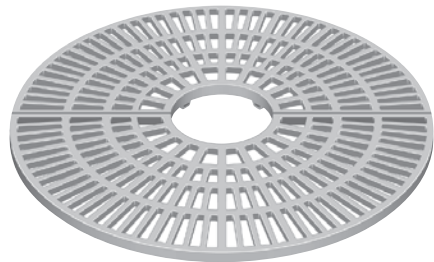

R-8847 • 50" Round

12" diameter expandable tree opening. 262 pounds per set.

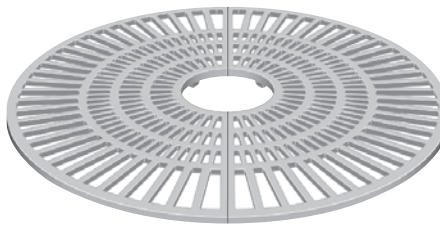

R-8849 • 56" Round

12" diameter expandable tree opening. 376 pounds per set.

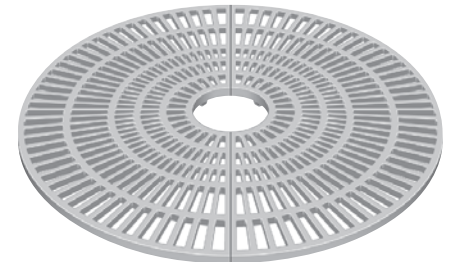

R-8851 • 66" Round

12" diameter expandable tree opening. 518 pounds per set.

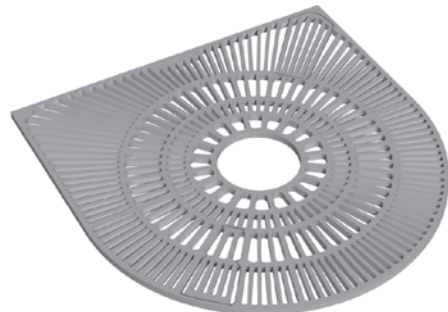

R-8931-1 • 72" Combo

16" diameter expandable tree opening. Bolted light opening grate for use with sub-grade lighting. 545 pounds per set. Supplied with two light grates, one on each half.

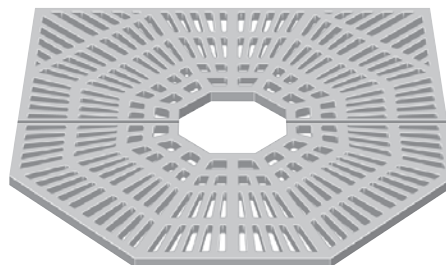

R-8937 • 64" Combo

16" octagonal tree opening. 716 pounds per set. No tree guards available for octagonal openings. Available with light openings.

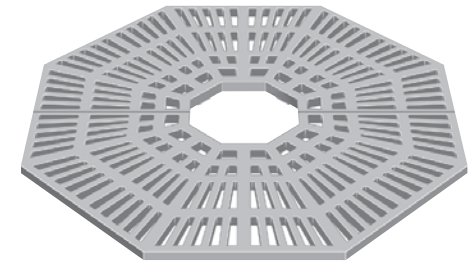

R-8952 • 64" Octagon

16" octagonal expandable tree opening. 640 pounds per set. No tree guards available for octagonal openings. Available with light openings.

Boulevard Collection

The radial pattern of the BOULEVARD collection combines a clean look with narrow slot openings to create a very versatile grate. Contact us for any special requirements and allow us to work with you in meeting your needs.

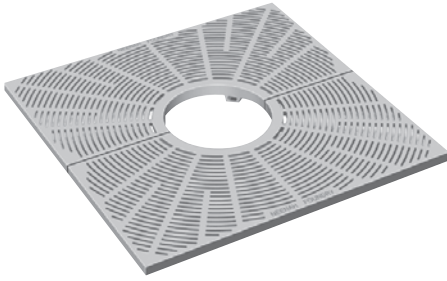

R-8708 • 48" x 48"

16" diameter expandable tree opening. Available with cast 20" and 24" tree opening upon request. .25" slot openings. 290 pounds per set. Available with light openings.

R-8708 is also a Los Angeles approved grate.

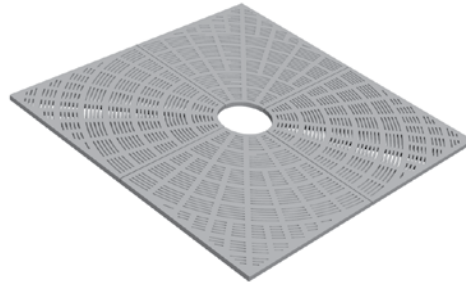

R-8711 • 95.125" x 95.125"

16" diameter tree opening. .375" slot openings. Frame supplies special support for 4-piece grate. 1280 pounds per set. Support at section joint is required — furnished by installer. Available with light openings.

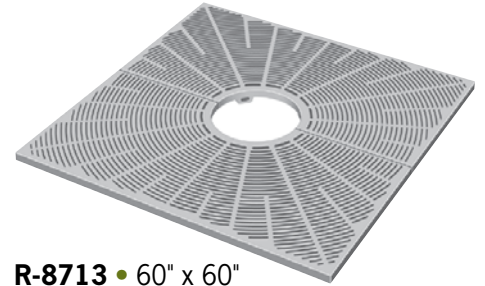

R-8713 • 60" x 60"

16" diameter expandable tree opening. Available with cast 18", 24" and 36" tree opening upon request. .25" slot openings. 380 pounds per set. Available with light openings.

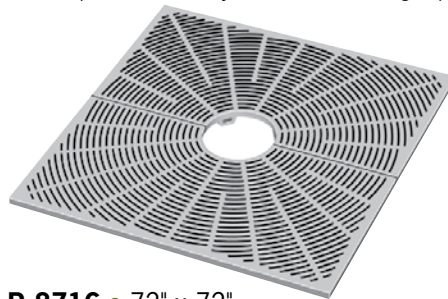

R-8716 • 72" x 72"

16" diameter expandable tree opening. .375" slot openings. 750 pounds per set. Available with cast 36" tree opening. Available with light openings.

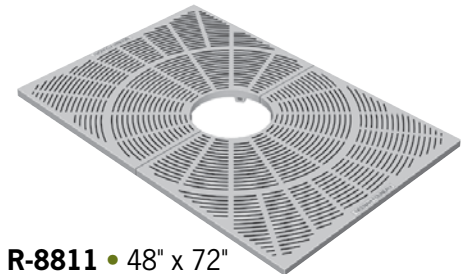

R-8811 • 48" x 72"

16" diameter expandable tree opening. Available with cast 12" tree opening. .375" slot openings. 394 pounds per set. Available with 22" tree opening.

R-8811-LA

Order as **R-8811-LA** for Los Angeles approved grate.

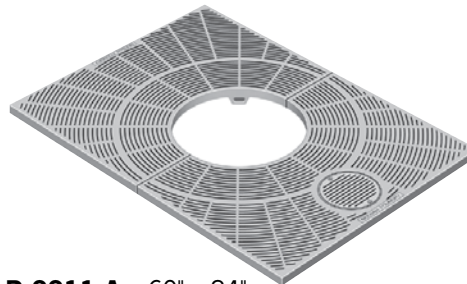

R-8811-A • 60" x 84"

30" diameter expandable tree opening. .375" slot openings. 456 pounds per set.

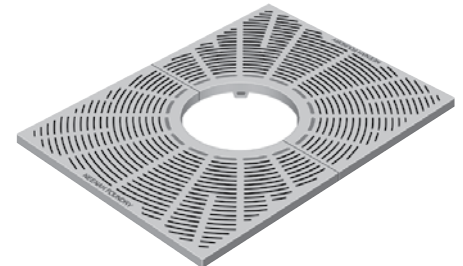

R-8814-A • 36" x 48"

16" diameter tree opening. .25" slot openings. 252 pounds per set. (Available with light openings, order as **R-8814**. 230 pounds per set.)

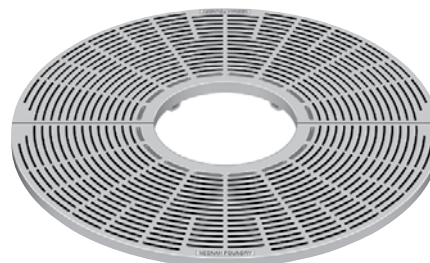

R-8832-A • 48" Round

16" diameter expandable tree opening. .25" slot openings. 250 pounds per set. (Available with light openings, order as **R-8832**. 248 pounds per set.)

R-8832-A and **R-8832** are also Los Angeles approved grates.



R-8838-A • 60" Round

16" diameter expandable tree opening. .25" slot openings. Available with 18" tree opening. 298 pounds per set. (Available with light openings, order as **R-8838**. 374 pounds per set. Available with 24" diameter expandable tree opening, order as **R-8838-A1**. 292 pounds per set. Available with 24" cast tree opening and light openings, order as **R-8838-1**. 344 pounds per set.)

R-8838-A and **R-8838** are also Los Angeles approved grates.



Capitol Collection

One of the most popular designs of yesteryear, the CAPITOL collection brings us back to an intriguing, time-tested offering.

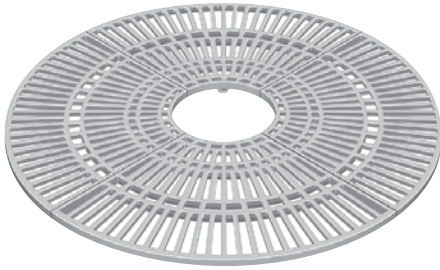

R-8839 • 75" Round

Four-piece, with 18" diameter expandable tree opening. Support at section joint is required — furnished by installer. 620 pounds per set. Available with light openings.

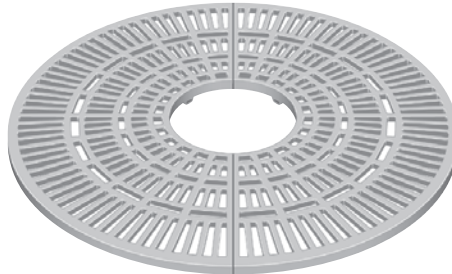

R-8843 • 56" Round

16" diameter expandable tree opening. 292 pounds per set. Available with light openings.

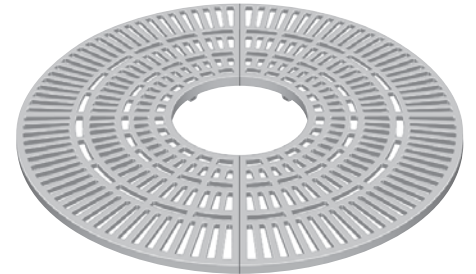

R-8843-A • 58.5" Round

18" diameter expandable tree opening. 284 pounds per set.

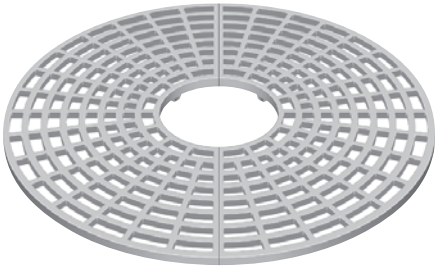

R-8857 • 72" Round

20" diameter expandable tree opening. 526 pounds per set.

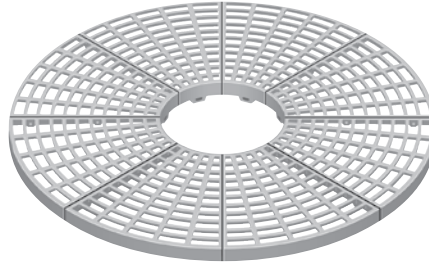

R-8861 • 96" Round

8-piece grate with 28" diameter tree opening. 1016 pounds per set. Support at section joint is required — furnished by installer.

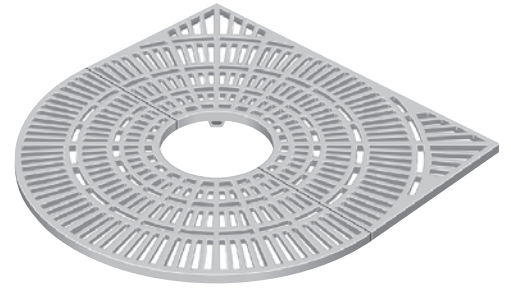

R-8927 • 56" Combo

16" diameter expandable tree opening. 324 pounds per set. Available with light openings.



Majestic Collection

The MAJESTIC collection was put together to address situations concerning large diameter tree trunks. Larger tree openings, expandability and narrow slot openings make these a great choice for palms and other mature trees.

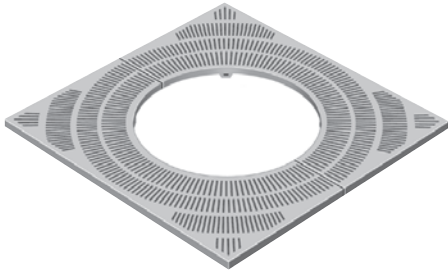

R-8717 • 60" x 60"
36" diameter tree opening. .25" slot openings. 440 pounds per set. (Available with removable insert grate and 16" tree opening, order as **R-8717-A**. 580 pounds per set.)
R-8717 is also a Los Angeles approved grate.

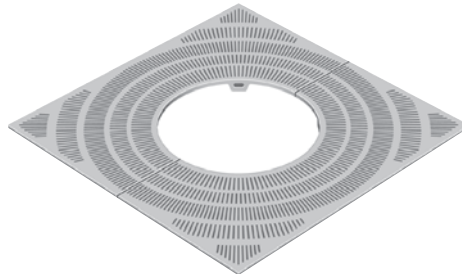

R-8718 • 72" x 72"
36" diameter tree opening. .25" slot openings. 750 pounds per set. Available with light openings.
R-8718 is also a Los Angeles approved grate.

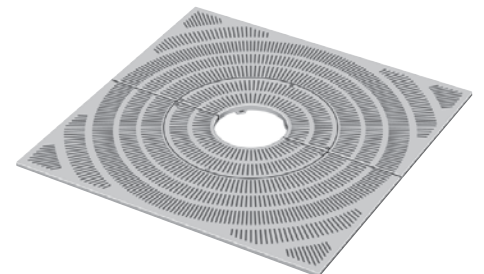

R-8718-A • 72" x 72"
Four-piece grate, 16" diameter tree opening, insert grate removes for 36" diameter tree opening. .25" slot openings. 850 pounds per set. Available with light openings.

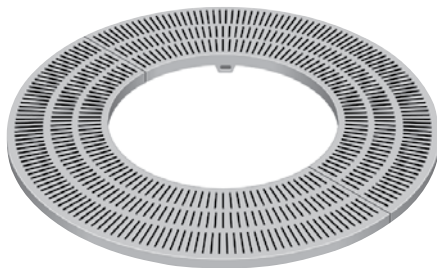

R-8871-1 • 60" Round
32" diameter expandable tree opening. .25" slot openings. 336 pounds per set. Available with light openings. (Available with 16" diameter expandable tree opening, order as **R-8871**. 376 pounds per set.)
R-8871-1 is also a Los Angeles approved grate.

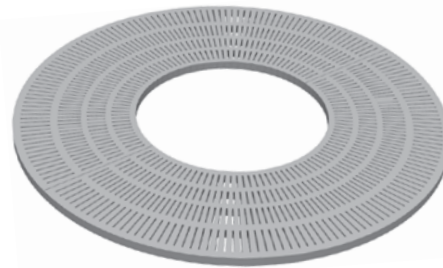

R-8871-B1 • 72" Round
32" diameter tree opening. .25" slot openings. 400 pounds per set.

Retrofit Collection

Developed specifically for use in an existing paved area, the RETROFIT collection is a popular alternative to poured-in-place grates. Level concrete can simply be cut to the necessary opening size. The overlapping edge covers any minor irregularities in the cut.

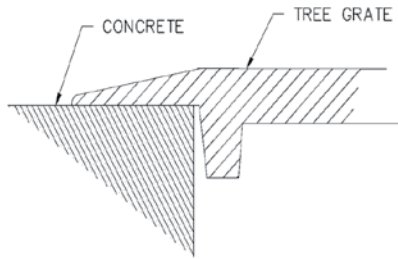

RETROFIT DETAIL

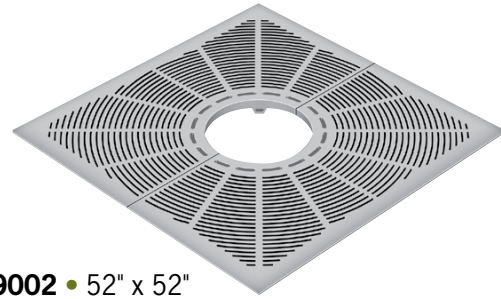

R-9002 • 52" x 52"

For 48" square opening. 16" diameter expandable tree opening. .25" slot openings. 266 pounds per set. Available with light openings. (Available for 60" opening, order as **R-9002-A**. 518 pounds per set. Available with light openings.)

R-9002-LA Order as **R-9002-LA** for Los Angeles approved grate.

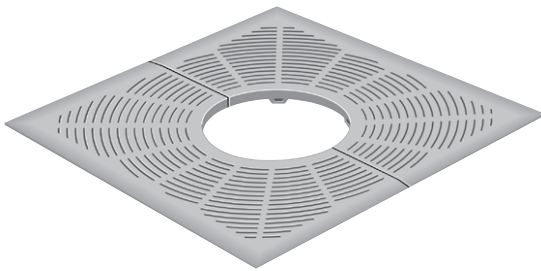

R-9003 • 40" x 40"

For 36" square opening. 16" diameter expandable tree opening. .25" slot openings. 175 pounds per set.

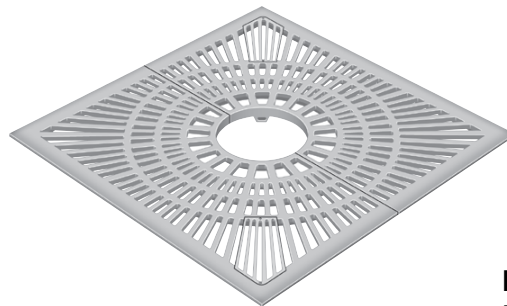

R-9004-1 • 62" x 62"

For 57.5" square opening. 16" diameter expandable tree opening. Bolted light opening grates (7.75" x 15.375" x 5.75") for use with sub-grade lighting. 440 pounds per set.

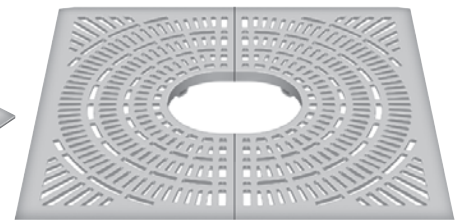

R-9101 • 59" x 54"

For 55" x 50" rectangular opening. 16" diameter oval expandable tree opening. 412 pounds per set. (Available as 54" square grate with round tree opening, order as **R-9101-A**. 354 pounds per set. Also available as 54" round grate with round 16" diameter tree opening, order as **R-9001**. 290 pounds per set.)

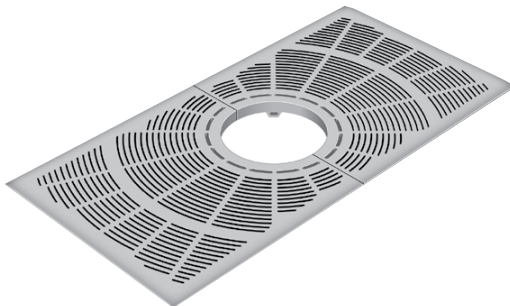

R-9105 • 36" x 72"

For 32" x 68" rectangular opening. 16" diameter expandable tree opening. .25" slot openings. 326 pounds per set.

R-9105 is also a Los Angeles approved grate.

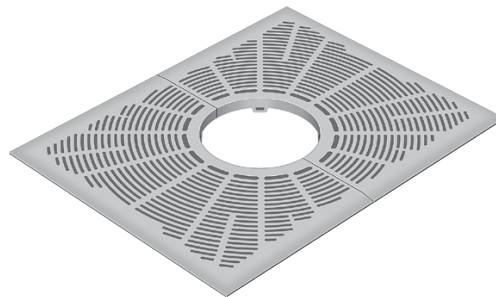

R-9106 • 40" x 52"

For 36" x 48" rectangular opening. 16" diameter expandable tree opening. .25" slot openings. 262 pounds per set.

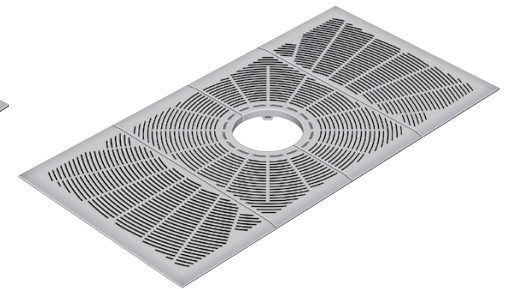

R-9107 • 52" x 100"

Four-piece grate, for 48" x 96" rectangular opening. 16" diameter expandable tree opening. .375" slot openings. This grate is a retrofit grate for use in existing paved areas. 642 pounds per set.

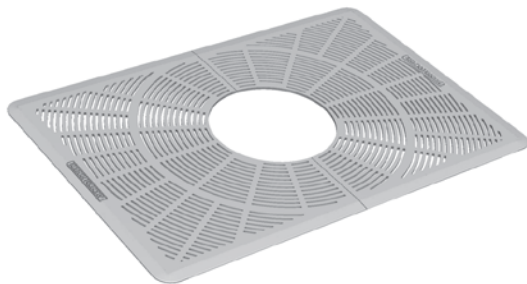

R-9108 • 52" x 76"

For 48" x 72" rectangular opening. 22" diameter expandable tree opening. .375" slot openings. 378 pounds per set.



Distinctive Collection

These one-of-a-kind tree grate concepts may be the perfect solution to your unique project. Contact us with your own ideas, and let Neenah be a part of your grate artistry.

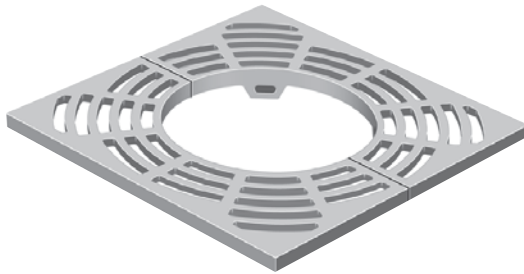

R-8700 • 30" x 30"
17.5" diameter expandable tree opening. 125 pounds per set.

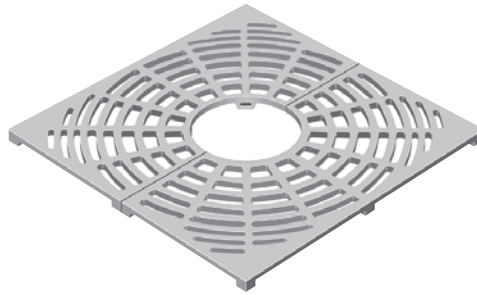

R-8702-A • 36" x 36"
12" diameter expandable tree opening. 140 pounds per set.

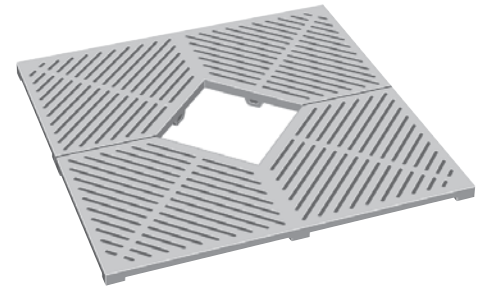

R-8724-A • 48" x 48"
15" square tree opening. .375" slot openings. 320 pounds per set.
R-8724-A is also a Los Angeles approved grate.

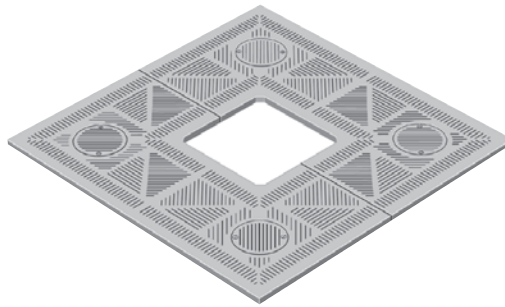

R-8737-B • 72" x 72"
23" square tree opening. Bolted light opening grates (10.375") for use with sub-grade lighting. .25" slot openings. 645 pounds per set. (Available as 60" x 60" square, order as **R-8737-C**. Also available with 30" square opening. 400 pounds per set.)

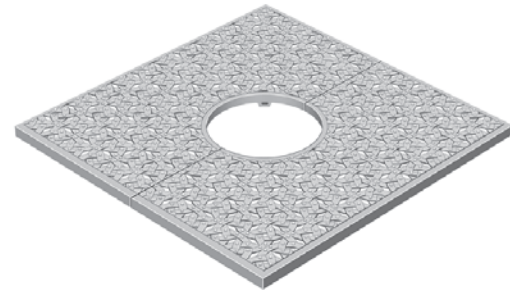

R-8759 • 48" x 48"
16" diameter tree opening. 320 pounds per set.
R-8759 is also a Los Angeles approved grate.

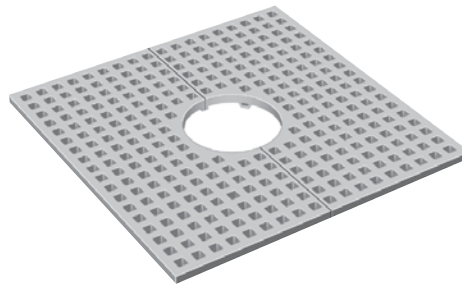

R-8762 • 60" x 60"
18" diameter tree opening. 950 pounds per set. Available with light openings.

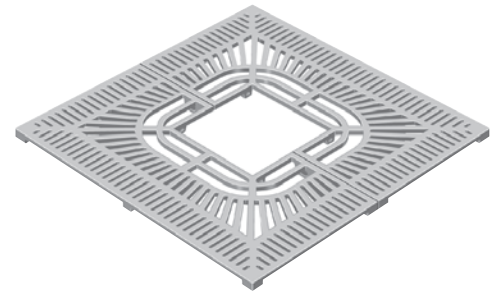

R-8768 • 48" x 48"
16" square tree opening. 190 pounds per set.

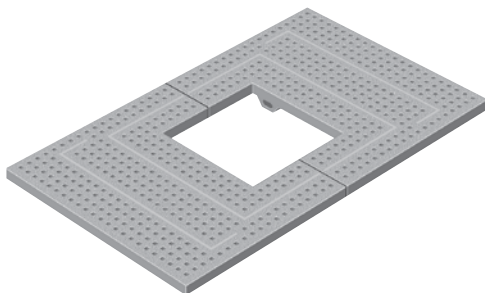

R-8820 • 36" x 60"
2-piece grate with 18" square opening. .5" square openings. 286 pounds per set.

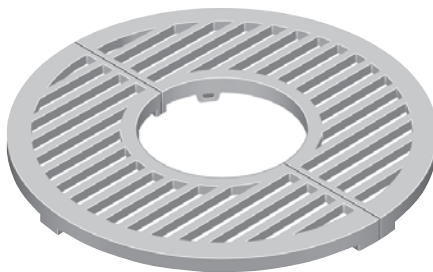

R-8825 • 30" Round
12" diameter tree opening. 80 pounds per set.

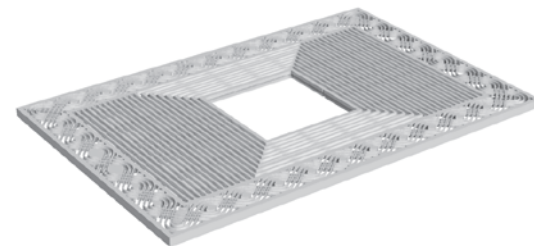

R-8850 • 48" x 72"
2-piece grate with 18" square tree opening. 380 pounds per set.

Greenwich Collection

If something a little different and very eye-catching is what you are after, consider the GREENWICH collection. These grates have the narrow slot openings and the visual appeal that many architects now seek in their landscape designs. If you don't see the size you want, give us a call.



R-8730 • 48" x 48"
17" diameter tree opening. 300 pounds per set.

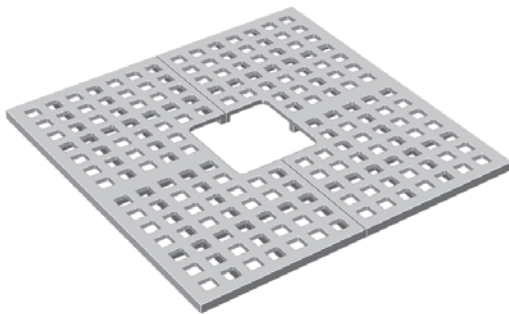

R-8760 • 60" x 60"
16" square expandable tree opening. 560 pounds per set.

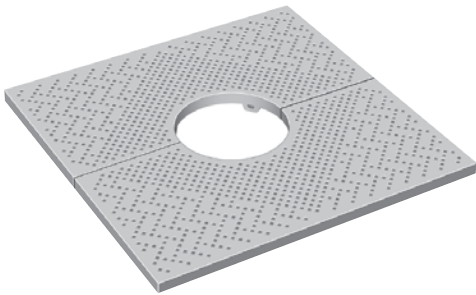

R-8770 • 48" x 48"
16" diameter tree opening. .5" round openings. 295 pounds per set.

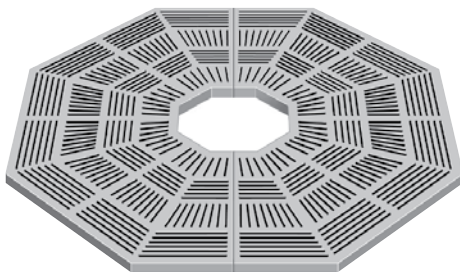

R-8953 • 64" Octagon
16" octagonal expandable tree opening. 516 pounds per set.
No tree guards available for octagonal openings.

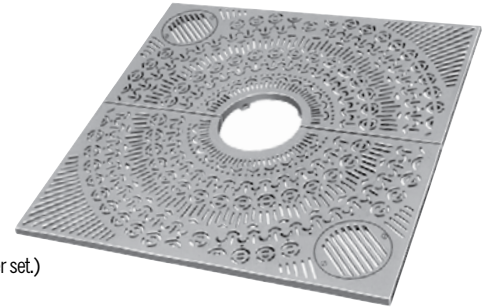

R-8754 • 60" x 60"
14" diameter tree opening. .375" typical slot openings.
Bolted light opening grates (10.375") for use with sub-grade lighting. 450 pounds per set. (Available without light openings, order as **R-8754-1**. 410 pounds per set.)
R-8754 is also a Los Angeles approved grate.

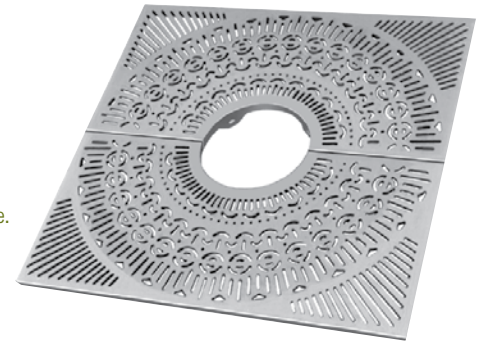

R-8757 • 48" x 48"
14" diameter tree opening. .375" typical slot openings.
306 pounds per set. Available with light openings.
Order as **R-8757-LA** for Los Angeles approved grate.

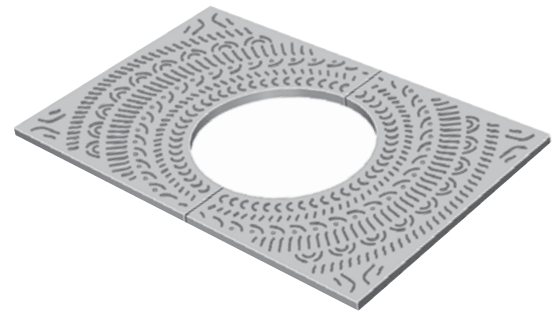

R-8819 • 48" x 72"
30" diameter tree opening.
.375" typical slot openings. 390 pounds per set.

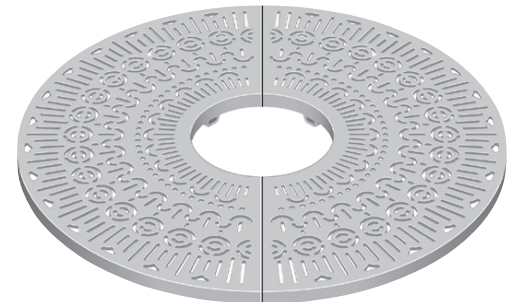

R-8874 • 48" Round
14" diameter tree opening. .375" typical slot openings.
220 pounds per set. Available with light openings.
R-8874 is also a Los Angeles approved grate.

Extended Collection

Where space and design consideration permit, the EXTENDED collection provides the opportunity to promote tree health through the use of larger tree pits. Many of our other collections can have extension grates created as well. Contact your Neenah representative with your needs.

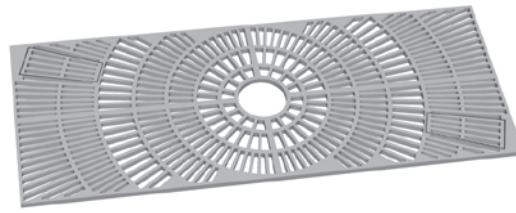

R-8806-1A • 48" x 120"
Four-piece grate, 12" diameter expandable tree opening. Bolted light opening grates (9" x 19" x 6") for use with sub-grade lighting. Support at section joint is required — furnished by installer. Parented with two light openings only. 720 pounds per set.

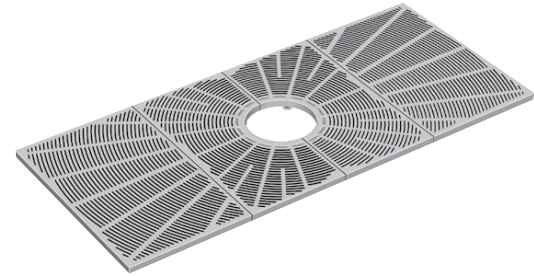

R-8813 • 48" x 107.75"
Four-piece grate, 16" diameter expandable tree opening. Total grate length can be increased with additional end sections. .25" slot openings. Available with 20" and 24" diameter tree opening. 636 pounds per set.
R-8813 is also a Los Angeles approved grate. Special frames and/or supports required.

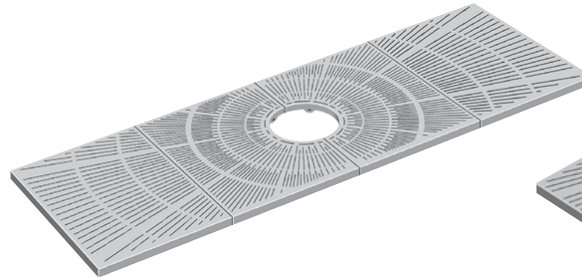

R-8815 • 48" x 144"
Four-piece grate, 18" diameter tree opening. .25" slot openings. 928 pounds per set. Available with 24" diameter tree opening. (Available as 48" x 120" 4-piece grate with 18" diameter tree opening, order as **R-8815-B4**. 898 pounds per set).

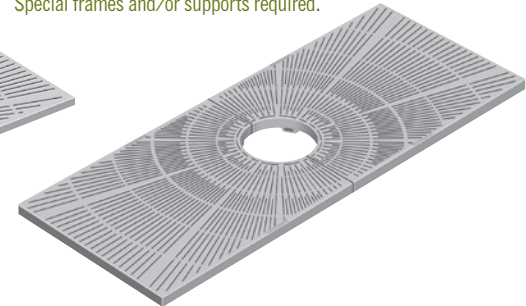

R-8815-B • 48" x 120"
Two-piece grate, 18" diameter tree opening. .25" slot openings. 762 pounds per set. (Available as 48" x 96" 2-piece grate with 18" and 26" diameter tree opening, order as **R-8815-A**. 646 pounds per set.)

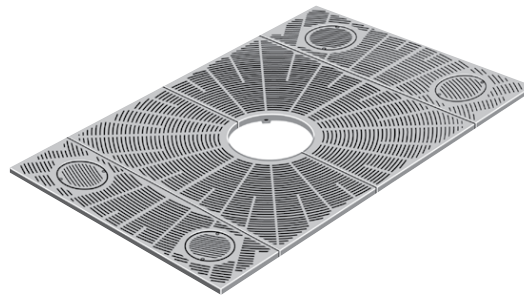

R-8816 • 60" x 95.75"
Four-piece grate, 18" diameter expandable tree opening. .25" slot openings. 706 pounds per set. Available in 16", 24" and 36" tree openings. Also available with no light openings.

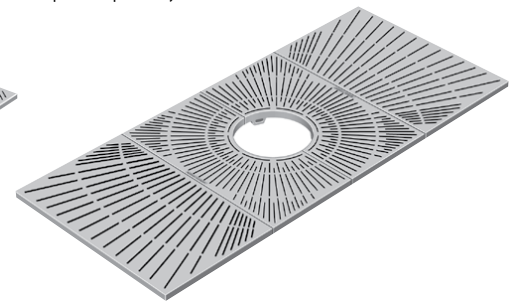

R-8817 • 48" x 108"
Four-piece grate, 18" diameter expandable tree opening. .25" slot openings. 685 pounds per set. Available with light openings.

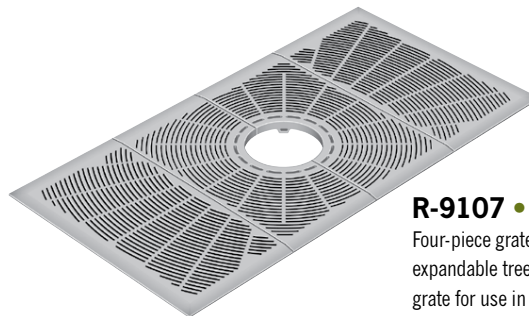

R-9107 • 52" x 100"
Four-piece grate, for 48" x 96" rectangular opening. 16" diameter expandable tree opening. .375" slot openings. This grate is a retrofit grate for use in existing paved areas. 642 pounds per set.

Express Your Identity

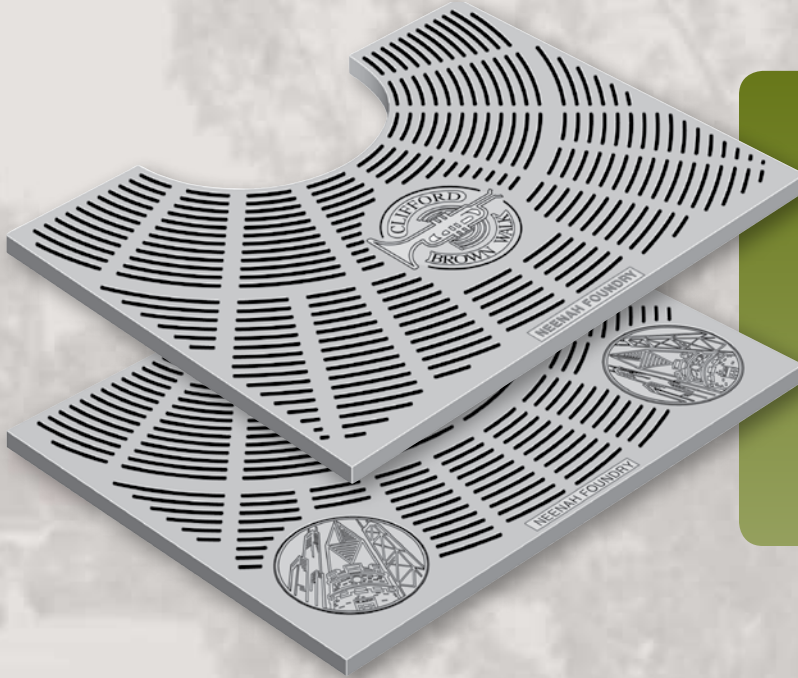

Does your company have a corporate insignia or municipal logo that you would like to incorporate into your architectural designs or construction project? Neenah Foundry has the ability to take your concepts and recreate them through Sidewalk Medallions, Tree Grate Logos and Custom Manhole Covers. This is a great opportunity to tie together a common municipal or corporate theme. Contact your Neenah representative with your ideas.



Fabricated Tree Guards

SPECIAL NOTE: Most tree grate units are furnished standard with four inconspicuous guard lugs on the underside to facilitate attachment of tree guards.

Neenah Tree Guards are manufactured from hot rolled, pickled and oiled mild steel in the five standard illustrated styles. Guards are designed to be attached in four places to bolting lugs which are integrally cast to the underside of the tree grate.

Neenah Tree Guards are manufactured using .5" flat and .625" square steel stock. Our use of these heavier materials sets Neenah's Tree Guards apart from the others, making for a stronger and more durable product.

Neenah furnishes guards completely assembled in two half sections. Guards are supplied with the vertical bars bolted to the rings. No tree guards are available for octagonal openings.

Tree guards are furnished with black powder coat paint. (Minimum thickness 2-mils.)

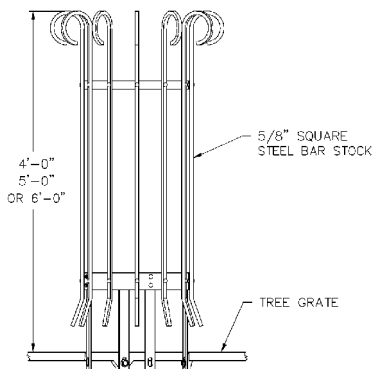

Type A

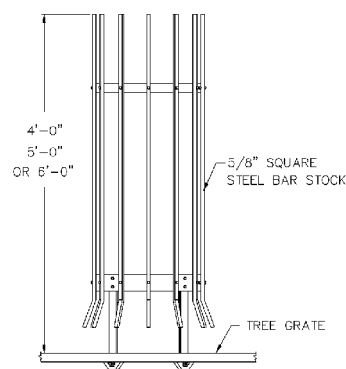

Type B

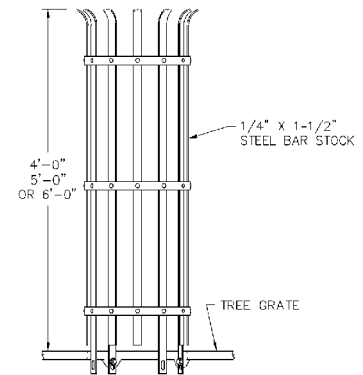

Type C

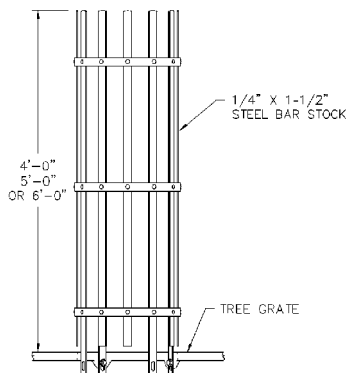

Type D

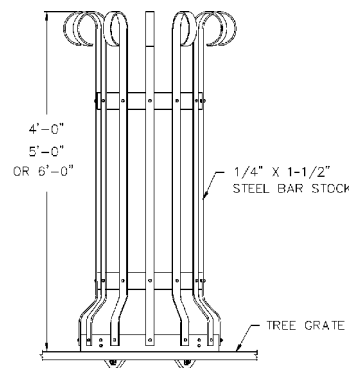

Type E

SPECIFY WHEN ORDERING:

1. Style
2. Dimension "L" (guard height as measured from top of grate – standard heights are 4', 5' or 6')
3. Tree opening diameter
4. Paint specifications if different from standard
5. Shop drawings for approval

ADVICE ON PLANTING TREES

Unusual stresses are imposed upon trees that grow in the urban environment: pollution, soil compaction, mechanical damage and restricted water and nutrients. As a result of these unfavorable conditions, many trees experience stunted growth or a shortened life span. Urban foresters and soil scientists are developing more exact approaches to the problems and requirements of urban trees. Through proper maintenance, species selection and special planting techniques, a tree's health can be greatly improved.

When planting trees in urban settings, one must provide enriched soil, proper drainage and a means of providing water and air to the roots for proper tree development.

Arborists encourage use of the largest tree pit possible—in response, Neenah offers our EXTENDED collection to meet this growing need.

See page 18 for what is currently available, or contact your Neenah sales representative with your ideas.

Neenah Tree Grates can provide the means of getting the proper moisture and air to the roots for a healthy, long-lived specimen.

No typical tree pit works for all situations. Urban designers must develop tree pits for each unique site. Soil scientists, arborists and urban foresters can provide valuable assistance when dealing with the following sub-surface conditions: aeration, drainage, irrigation and feeding, enriched soil, methods of flushing salts and/or avoiding their accumulation and methods of minimizing future soil compaction.

LIGHTING

Trees are beautiful in daylight – yet in the darkness of the night they become shapeless and non-descript. Extend their natural beauty through the hours of darkness with tree grate illumination. Most Neenah Tree Grates can be made with removable light-opening sections so that sub-grade lighting units can be easily installed. All light-opening sections are secured with countersunk screws to prevent unauthorized removal.



PAINTING TREE GRATES and TREE GUARDS

Because of the unique properties of cast iron, tree grates from Neenah do not require painting for corrosion protection. The natural patina of an unpainted tree grate will be a pleasant complement to the trees and surrounding paved area – particularly in outdoor installations – and it has the added benefit of requiring no future maintenance.

For customers who choose to install painted grates, Neenah Foundry can offer the following:

BLACK PRIMER

This is a primer coating, ready to accept your finished coat. Neenah Foundry recommends the application of a finish coat for the best coverage.

BLACK POWDER COAT FINISH

This low gloss finish coat is applied with a minimum 2-mil thickness – our best offering.

CUSTOMER SPECIFIED

Please advise your paint specification.

FABRICATED STEEL TREE GUARDS ARE FURNISHED STANDARD WITH BLACK POWDER COAT PAINT. (MINIMUM THICKNESS 2-MILS).

PEDESTRIAN SAFETY

Neenah offers a wide variety of tree grates with narrow openings of .375" or less for areas where your special pedestrian requirements may need to be taken into consideration.

As part of your landscaping plan, we recommend that pathways be provided which do not direct foot traffic over the tree grate installation. Near these pathways, or in any area that is potentially subject to foot traffic, we recommend the use of a narrow opening tree grate style.

IT IS THE RESPONSIBILITY OF THE PROJECT DESIGNER TO DETERMINE IF SPECIAL PEDESTRIAN REQUIREMENTS ARE NECESSARY AND SUBSEQUENTLY TO SELECT GRATE STYLES AND LOCATIONS THAT MEET THOSE REQUIREMENTS. NEENAH RECOMMENDS DESIGNERS CAREFULLY EVALUATE PREVAILING LOCAL, REGIONAL, STATE AND FEDERAL SPECIFICATIONS, INCLUDING, BUT NOT LIMITED TO ADA (AMERICANS WITH DISABILITIES ACT) WHEN MAKING THEIR SELECTIONS.

As an additional safety precaution for pedestrians, as well as protection for your young trees, you may want to specify a tree guard to direct foot traffic away from the tree opening. See page 18 for our selection of fabricated tree guards.

SECURITY BOLTING

The best security a tree grate has is inherent in its own size and weight. For additional security needs, grates can be bolted to their frames at the factory and shipped assembled to the job site. Standard security bolting is done with flathead screws, countersunk flush with the grate surface. Greater security is available through the use of various tamper-proof bolts. Security bolting and tamper-proof bolting can be requested for most of our tree grate line.

Installation Procedures

Neenah's tree grate frames are designed to make the installation job easy and accurate. Our frames can be incorporated into your forms in just minutes. The seat of the frame should be cleaned prior to setting the grate. Grate halves are to be bolted together on the underside using the bolt slots provided.

ALL OR ANY PART OF THE PRECEDING SPECIFICATIONS AND PROCEDURES MAY BE INCORPORATED IN YOUR PROJECT DOCUMENTS.

FOR POURED CONCRETE INSTALLATIONS

(Neenah tree grates and R-8500 Type U frames)

Step 1

Excavate tree pit.

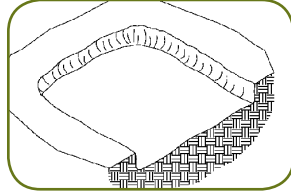

Step 2

Place wood frame within excavation. Set at proper grade. Make form outside dimension 45.75" x 45.75" for 48" x 48" grate, 57.75" x 57.75" for 60" x 60" grate or 69.75" x 69.75" for 72" x 72" grate.

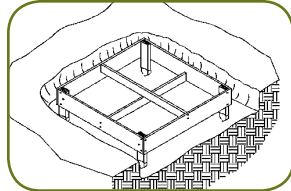

Step 3

Assemble the R-8500 Type U tree grate frame using the hardware provided. Make sure to tighten the countersunk flathead screws so they are flush or below the bearing surface of the frame.

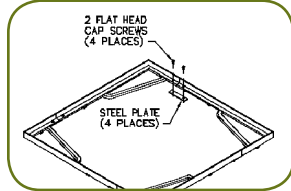

Step 4

Place frame on wood form. Place both tree grate halves within the frame.

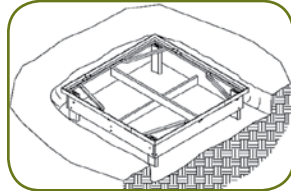

Step 5

IMPORTANT: Wire grates, frames and form together. Check and adjust frame alignment and elevation if needed. Install #3 rebar through lugs on frame and support as required. Ensure there is a .1875" spacing between vertical faces of the frame and grate.

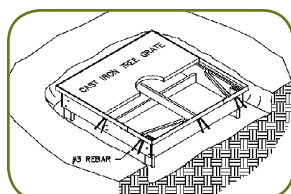

Step 6

Pour and finish concrete. Do not remove tree grate or trim alignment wires until concrete has set up.

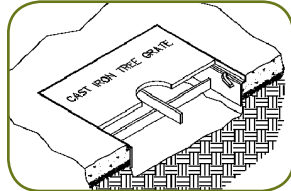

FOR PAVING BLOCK INSTALLATIONS

(Neenah tree grates and R-8500 Type P frames)

Step 1

Excavate tree pit.

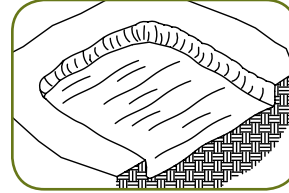

Step 2

Place assembly within excavation. Set at proper grade.

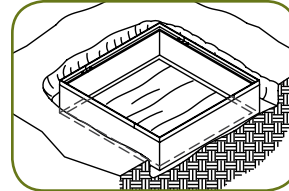

Step 3

Place both tree grate halves within the frame.

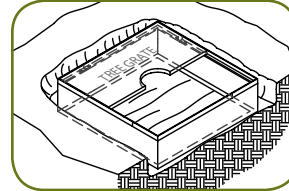

Step 4

Place setting bed and pavers, plant tree.

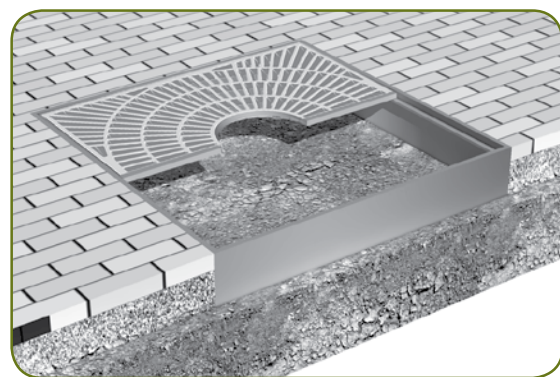
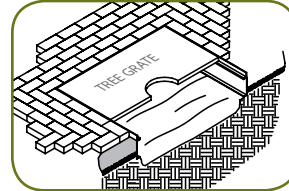

Example of R-8500 Type P frame.

NOTE: FAILURE TO FOLLOW THESE FORMING PROCEDURES COULD RESULT IN AN UNSATISFACTORY INSTALLATION.

If you have any questions regarding installation or if you must deviate from the above instructions, contact the Neenah Product Engineering Department. Additional detailed installation information is available from your Neenah sales representative or from our web site at www.neenahfoundry.com.

EXPANDABLE – Neenah Foundry cast iron tree grates provide the advantage of being easily expandable without losing their structural integrity. As trees grow through the years, the tree opening can be enlarged in increments to accommodate the larger trunk. The best method to expand the opening is through the use of an abrasive cutting wheel, notching the radial spokes at the junction of the expansion rings, then breaking away the portion to be discarded.

Trench Systems

Neenah offers a wide selection of heavy duty trench castings with grated and solid covers. Our standard R-4990 series and bolted R-4999 series trench covers and angle frames work with trench openings ranging from 6" through 48".

STANDARD CATALOG #	BOLTED CATALOG #				AVAILABLE GRATE/COVER
		A	B	C	
R-4990-AX	R-4999-AX	8	1.5	6	A, C, D, E, P
R-4990-BX	R-4999-BX	10	1.5	8	A, C, D, E, P
R-4990-CX	R-4999-CX	12	1.5	10	A, C, D, E, P, Q
R-4990-DX	R-4999-DX	14	1.5	12	A, C, D, E, P, Q
R-4990-EX	R-4999-EX	17	1.5	15	A, C, D, E, P
R-4990-FX	R-4999-FX	20	1.5	18	A, C, D, E, P
R-4990-GX	R-4999-GX	23	1.5	21	A, C, D
R-4990-HX	R-4999-HX	26	1.5	24	A, C, D, Q
R-4990-JX	R-4999-JX	30	2	27	A, C, D
R-4990-KX	R-4999-KX	33	2	30	A, C, D, E
R-4990-LX	R-4999-LX	36	2	33	A, C, D
R-4990-MX	R-4999-MX	39	2	36	A, C, D
R-4990-NX	R-4999-NX	45	2	42	A, C, D
R-4990-OX	R-4999-OX	51	2	48	A, D

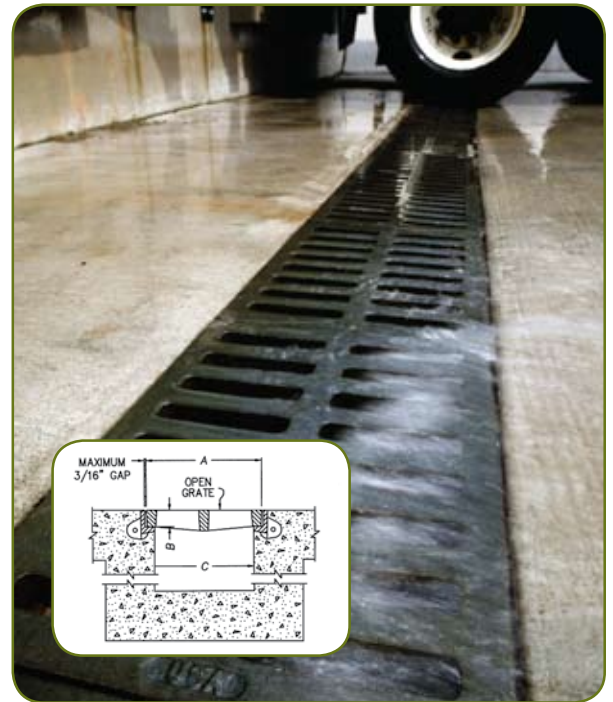
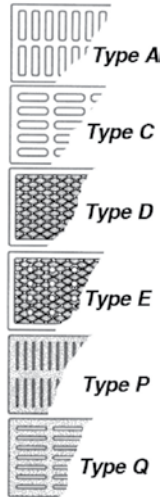

R-4996-A Riverwalk

Grates are 29.875" x 8".
.25" slot openings. 31 pounds each.

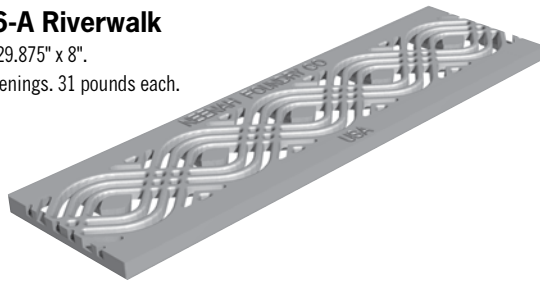

SELF-FORMING TRENCH PAN

Our self-forming trench systems provide the durability and permanence of cast iron, easy and economical installation and proven hydraulic performance. Units can be furnished bolted or unbolted, and the type Q grates can easily be incorporated into plans for ADA compliance*.

Contact us for complete information on this trench series.

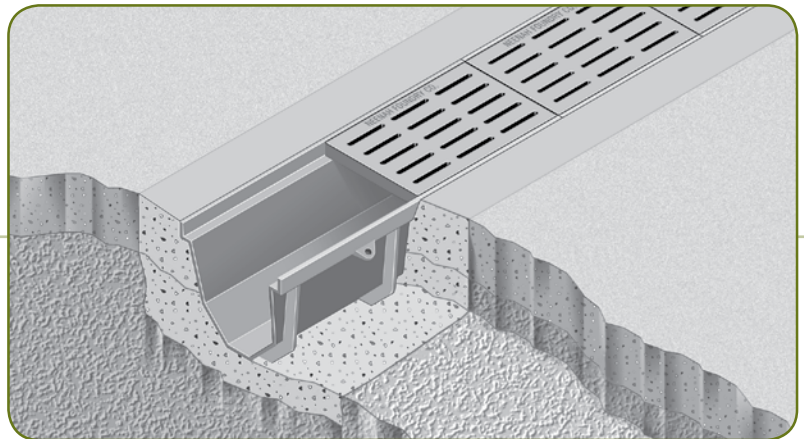

SELF-FORMING TRENCHES

CATALOG #	A	B	C	D	FRAME LENGTH	OUTLET LOCATION, SIZES AVAILABLE			AVAILABLE GRATE/COVER
						SIDE	BOTTOM	END	
R-4996-A	8	1	6	9	30	4, 6	4	4	Q*
R-4996-B	10	1	8	10.375	30	4, 6, 8	4, 6	4, 6	Q*
R-4996-C	12	1.5	10	10	36	4, 6, 8	4, 6, 8	4, 6, 8	A, C, D, L, Q*

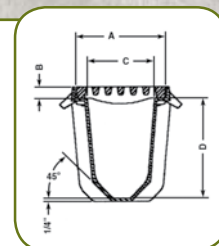

Tree Grate Reference Guide by Size & Shape

Los Angeles Approved Grates in Green

Size	Cat#	Collection	Page	Size	Cat#	Collection	Page	Size	Cat#	Collection	Page
RECTANGULAR				60"	R-8752-A	Parkway	9	96"	R-8861	Capitol	11
36" x 48"	R-8814	Boulevard	10	60"	R-8752-B	Parkway	9	96"	R-8883	Metropolitan	6
36" x 48"	R-8814-A	Boulevard	10	60"	R-8754	Greenwich	15	31.75"	R-8827	Adirondack	4
36" x 60"	R-8810	Avenue	5	60"	R-8754-1	Greenwich	15	39.75"	R-8827-A1	Adirondack	4
36" x 60"	R-8820	Distinctive	14	60"	R-8760	Distinctive	15	55.75"	R-8872	Avenue	5
36" x 72"	R-8808	Parkway	8	60"	R-8762	Distinctive	14	58.5"	R-8843-A	Capitol	11
36" x 72"	R-8809	Metropolitan	7	64"	R-8766	Parkway	9	RETROFIT			
48" x 72"	R-8850	Distinctive	14	72"	R-8709-A	Metropolitan	7	40"	R-9003	Retrofit	13
48" x 72"	R-8802-A	Parkway	8	72"	R-8715	Avenue	5	52"	R-9002	Retrofit	13
48" x 72"	R-8811	Boulevard	10	72"	R-8716	Boulevard	10	52"	R-9002-LA	Retrofit	13
48" x 72"	R-8811-LA	Boulevard	10	72"	R-8718	Majestic	12	54"	R-9101-A	Retrofit	13
48" x 72"	R-8815-1	Extended	16	72"	R-8718-A	Majestic	12	62"	R-9004-1	Retrofit	13
48" x 72"	R-8819	Greenwich	15	72"	R-8737-B	Distinctive	14	64"	R-9001	Retrofit	13
60" x 84"	R-8811-A	Boulevard	10	72"	R-8738-1	Parkway	9	64"	R-9002-A	Retrofit	13
95.125" x 119.125"	R-8821	Parkway	8	72"	R-8738-2	Parkway	9	64"	R-9105	Retrofit	13
SQUARE				72"	R-8740-1	Parkway	8	40" x 52"	R-9106	Retrofit	13
30"	R-8700	Distinctive	14	95.125"	R-8784	Metropolitan	6	52" x 76"	R-9108	Retrofit	13
30"	R-8704	Avenue	5	95.125"	R-8711	Boulevard	10	52" x 100"	R-9107	Retrofit	13
36"	R-8702-A	Distinctive	14	ROUND				59" x 54"	R-9101	Retrofit	13
36"	R-8704-A	Avenue	5	30"	R-8825	Distinctive	14	EXTENDED			
36"	R-8704-A LA	Avenue	5	30"	R-8881	Avenue	5	48" x 96"	R-8815-A	Extended	16
48"	R-8706-1A	Metropolitan	6	36"	R-8834	Metropolitan	6	48" x 120"	R-8815-B	Extended	16
48"	R-8706-A	Metropolitan	6	42"	R-8829	Adirondack	4	48" x 120"	R-8815-B4	Extended	16
48"	R-8708	Boulevard	10	48"	R-8830-1	Metropolitan	7	48" x 108"	R-8813	Extended	16
48"	R-8710	Avenue	5	48"	R-8830-A1	Metropolitan	7	48" x 120"	R-8806-1A	Extended	16
48"	R-8719	Metropolitan	7	48"	R-8832	Boulevard	10	48" x 144"	R-8815	Extended	16
48"	R-8721-A	Parkway	8	48"	R-8832-A	Boulevard	10	60" x 95.75"	R-8816	Extended	16
48"	R-8724-A	Distinctive	14	48"	R-8874	Greenwich	15	48" x 108"	R-8817	Extended	16
48"	R-8726	Parkway	8	50"	R-8833	Adirondack	4	52" x 100"	R-9107	Extended	16
48"	R-8730	Distinctive	15	50"	R-8847	Parkway	9	MULTI-SIDED			
48"	R-8742	Adirondack	4	54"	R-8855-2	Parkway	8	44.5"	R-8950	Adirondack	4
48"	R-8750	Parkway	8	56"	R-8843	Capitol	11	60"	R-8955	Adirondack	4
48"	R-8752-2	Parkway	9	56"	R-8849	Parkway	9	60"	R-8965	Metropolitan	7
48"	R-8757	Greenwich	15	60"	R-8837-1	Adirondack	4	64"	R-8952	Parkway	9
48"	R-8757-LA	Greenwich	15	60"	R-8837-A	Adirondack	4	64"	R-8953	Distinctive	15
48"	R-8759	Distinctive	14	60"	R-8838	Boulevard	10	64"	R-8937	Parkway	9
48"	R-8768	Distinctive	14	60"	R-8838-1	Boulevard	10	COMBINATION			
48"	R-8770	Distinctive	15	60"	R-8838-A	Boulevard	10	56"	R-8927	Capitol	11
60"	R-8707-LA	Metropolitan	6	60"	R-8838-A1	Boulevard	10	60"	R-8933-A	Metropolitan	7
60"	R-8712	Avenue	5	60"	R-8869-A	Metropolitan	7	62"	R-8929	Parkway	8
60"	R-8713	Boulevard	10	60"	R-8869-ALA	Metropolitan	7	64"	R-8937	Parkway	9
60"	R-8714-A	Metropolitan	7	60"	R-8870	Metropolitan	7	72"	R-8931-1	Parkway	9
60"	R-8714-ALA	Metropolitan	7	60"	R-8871	Majestic	12	72"	R-8939	Avenue	5
60"	R-8717	Majestic	12	60"	R-8871-1	Majestic	12	OTHER			
60"	R-8717-A	Majestic	12	66"	R-8851	Parkway	9	Custom Logos			17
60"	R-8728-A	Parkway	8	72"	R-8855-1	Parkway	8	Medallions			17
60"	R-8734	Parkway	9	72"	R-8857	Capitol	11	Tree Guards			18
60"	R-8737-C	Distinctive	14	72"	R-8876	Avenue	5				
60"	R-8738-A1	Parkway	9	72"	R-8876-1	Avenue	5				
60"	R-8738-A2	Parkway	9	72"	R-8880-A	Metropolitan	6				
60"	R-8742-A	Adirondack	4	72"	R-8871-B1	Majestic	12				
60"	R-8742-A1	Adirondack	4	75"	R-8839	Capitol	11				
60"	R-8746-A	Adirondack	4	93"	R-8860	Adirondack	4				

Tree Grate Reference Guide by Code

Los Angeles Approved Grates in Green

Cat#	Page	Cat#	Page	Cat#	Page
R-8700	14	R-8757-LA	15	R-8849	9
R-8702-A	14	R-8759	14	R-8850	14
R-8704	5	R-8760	15	R-8851	9
R-8704-A	5	R-8762	14	R-8855-1	8
R-8704-A LA	5	R-8766	9	R-8855-2	8
R-8706-1A	6	R-8768	14	R-8857	11
R-8706-A	6	R-8770	15	R-8860	4
R-8707	6	R-8784	6	R-8861	11
R-8707-LA	6	R-8802-A	8	R-8869-A	7
R-8708	10	R-8806-1A	16	R-8869-ALA	7
R-8709-A	7	R-8808	8	R-8870	7
R-8710	5	R-8809	7	R-8871	12
R-8711	10	R-8810	5	R-8871-1	12
R-8712	5	R-8811	10	R-8871-B1	12
R-8713	10	R-8811-A	10	R-8872	5
R-8714-A	7	R-8811-LA	10	R-8874	15
R-8714-A LA	7	R-8813	16	R-8876	5
R-8715	5	R-8814	10	R-8876-1	5
R-8716	10	R-8814-A	10	R-8880-A	6
R-8717	12	R-8815	16	R-8881	10
R-8717-A	12	R-8815-1	16	R-8882	5
R-8718	12	R-8815-A	16	R-8883	6
R-8718-A	12	R-8815-B	16	R-8927	11
R-8719	7	R-8815-B4	16	R-8929	8
R-8721-A	8	R-8816	16	R-8931-1	9
R-8724-A	14	R-8817	16	R-8933-A	7
R-8726	8	R-8819	15	R-8937	9
R-8728-A	8	R-8821	8	R-8939	5
R-8730	15	R-8820	14	R-8950	4
R-8734	9	R-8825	14	R-8952	9
R-8737-B	14	R-8827	4	R-8953	15
R-8737-C	14	R-8827-A1	4	R-8955	4
R-8738-1	9	R-8829	4	R-8965	7
R-8738-2	9	R-8830-1	7	R-9001	13
R-8738-A1	9	R-8830-A1	7	R-9002	13
R-8738-A2	9	R-8832	10	R-9002-A	13
R-8740-1	8	R-8832-A	10	R-9002-LA	13
R-8742	4	R-8833	4	R-9003	13
R-8742-A	4	R-8834	6	R-9004-1	13
R-8742-A1	4	R-8837-1	4	R-9101	13
R-8746-A	4	R-8837-A	4	R-9101-A	13
R-8750	8	R-8838	10	R-9105	13
R-8752-2	9	R-8838-1	10	R-9106	13
R-8752-A	9	R-8838-A	10	R-9107	13,16
R-8752-B	9	R-8838-A1	10	R-9108	13
R-8754	15	R-8839	11	Custom Logos	17
R-8754-1	15	R-8843	11	Medallions	17
R-8757	15	R-8843-A	11	Tree Guards	18
		R-8847	9		

REGIONAL SALES OFFICES AND DISTRIBUTION CENTERS

Phoenix, AZ
Phone: 602 225-9801
Toll Free: 866 765-0850
Fax: 602 220-0354

Los Angeles (El Monte), CA
Phone: 760 535-2267
Toll Free: 866 765-0850
Fax: 602 220-0354

Denver (Commerce City), CO
Phone: 303 289-7192
Toll Free: 800 694-4660
Fax: 303 289-7193

Chicago (Carol Stream), IL
Phone: 630 653-5440
Toll Free: 800 874-4457
Fax: 630 653-0170

Rockford, IL
Phone: 815 399-2228
Toll Free: 800 892-0750
Fax: 815 399-6765

Indianapolis, IN
Phone: 317 875-7245
Toll Free: 800 382-1359
Fax: 317 875-8637

Minneapolis-St. Paul (Shakopee), MN
Phone: 952 445-5335
Toll Free: 800 252-5801
Fax: 952 445-6417

St. Louis (St. Peters), MO
Phone: 636 928-1023
Toll Free: 800 392-8062
Fax: 636 928-4727

Lincoln, NE (Deeter Foundry)
Phone: 402 464-7466
Toll Free: 800 234-7466
Fax: 402 464-8533

Albany, NY
Phone: 518 458-CAST [2278]
Toll Free: 888 769-2278
Fax: 518 458-2280

Cincinnati, OH
Phone: 513 621-6735
Toll Free: 800 423-8116
Fax: 614 876-0216

Cleveland, OH
Phone: 614 876-9837
Toll Free: 800 423-8116
Fax: 614 876-0216

Columbus, OH
Phone: 614 876-9837
Toll Free: 800 423-8116
Fax: 614 876-0216

Oklahoma City, OK
Phone: 405 942-8118
Toll Free: 800 619-6756
Fax: 405 942-7057

Pittsburgh (Cuddy), PA
Phone: 412 221-1789
Toll Free: 877 758-8940
Fax: 412 221-1863

Milwaukee (Waukesha), WI
Phone: 262 544-9900
Fax: 262 544-9964

Manufacturer's Representatives are located in many principal cities throughout the United States. Please call for the location nearest you, or visit our website at www.neenahfoundry.com.

"Word on the Street is Neenah"

800-558-5075 • WWW.NEENAHFOUNDRY.COM

Neenah Foundry
"Word on the Street is Neenah"

Since 1872, Neenah Foundry has been known for consistent quality, functional performance and design aesthetics. We're also proud of a reputation for responsive support and service. When you choose Neenah Foundry, you've chosen the best.

Neenah offers an extensive selection of castings for construction and municipal use including manhole covers and frames, catch basins and curb inlets, cast iron downspouts, tree grates, bridge scuppers, detectable warning plates and many other specialty products.

Contact any Neenah Foundry office for more information. Visit www.neenahfoundry.com to order our catalogs and brochures or to locate your local Neenah Foundry representative.



Spring Assist



LiftMate



Camlift



Downspouts

NEENAH  FOUNDRY

Neenah Foundry Company
Box 729, Neenah, Wisconsin 54957-0729
800-558-5075 | www.neenahfoundry.com
920-725-7000 | Fax: 920-729-3661

These products are to be specified and used under the guidance of qualified design professionals.

Neenah Foundry Co. is a subsidiary of

